

TYP_D

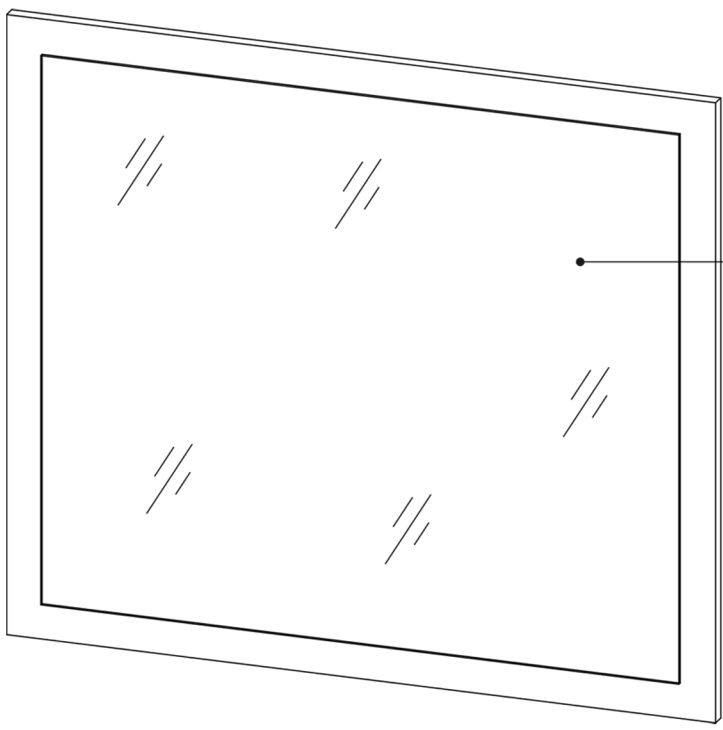

①	800	700	19 x1	1/1
				1/1

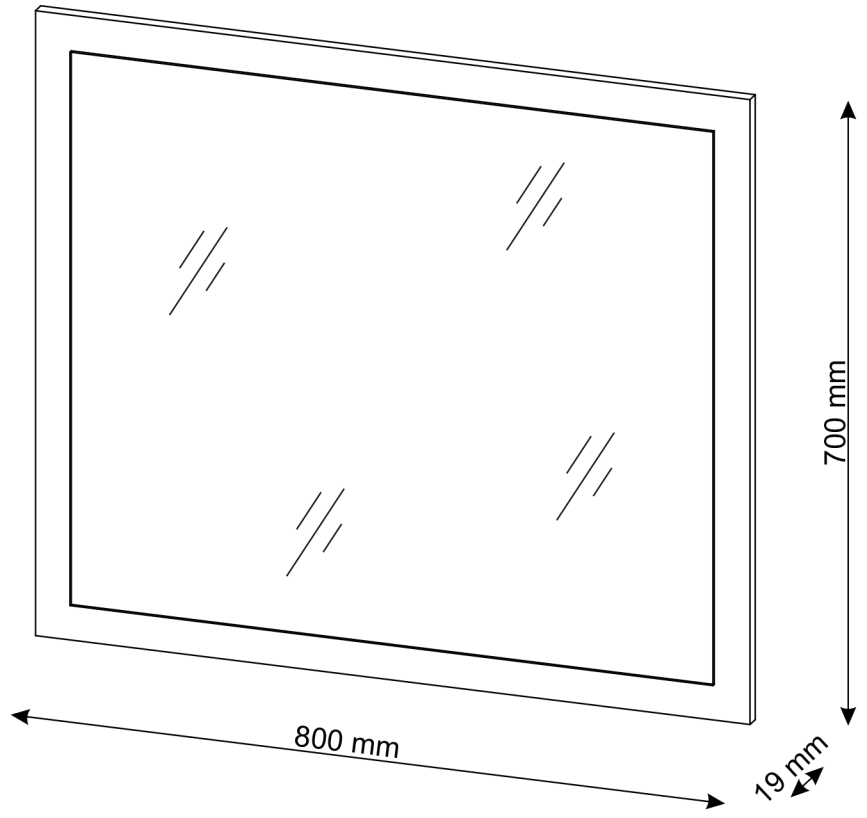

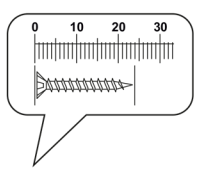
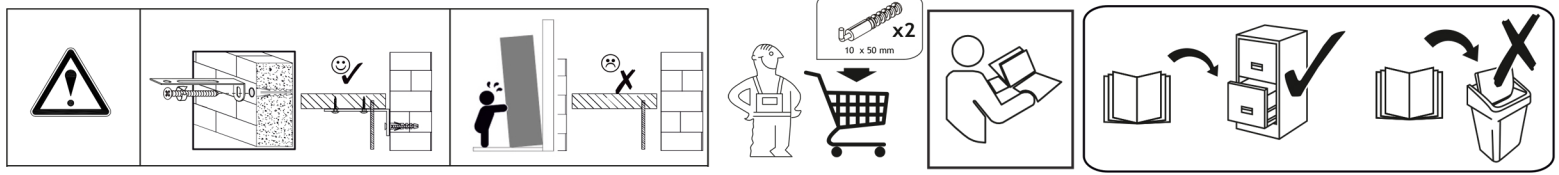
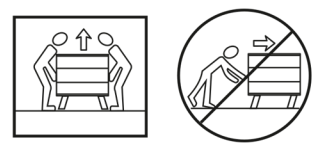

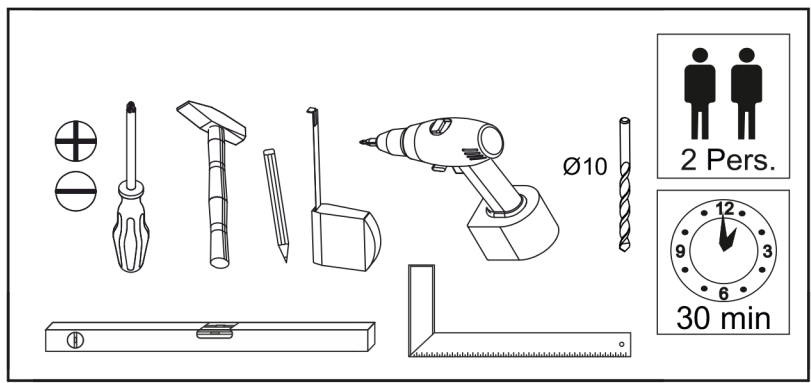
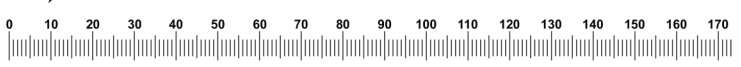
D22	P1	U0
5x11 x4	x2	x2

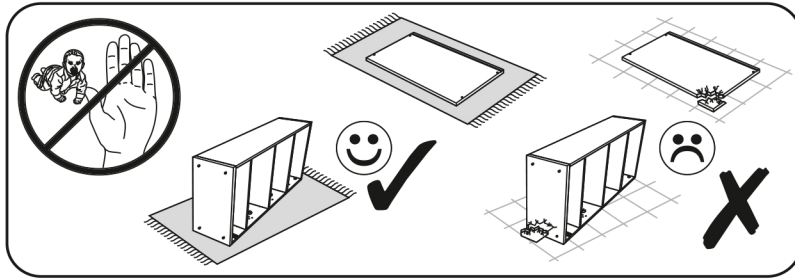

1



D22	P1	U0
		
5x11		
x4	x2	x2

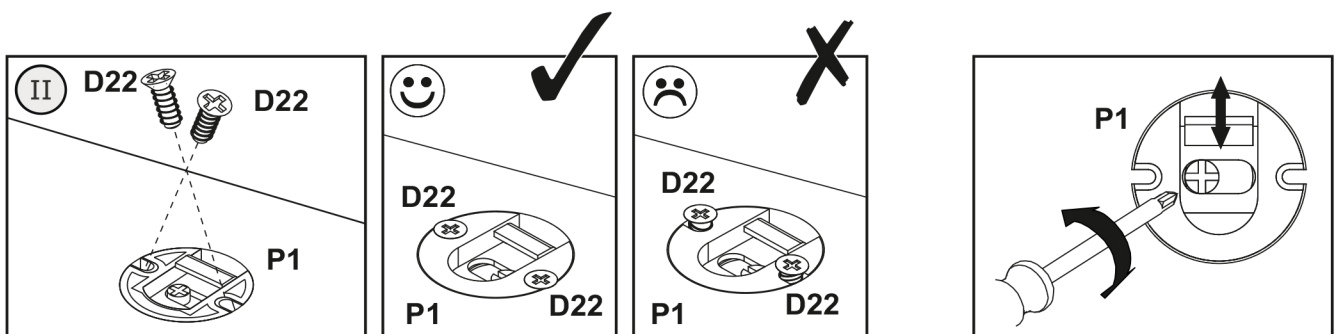
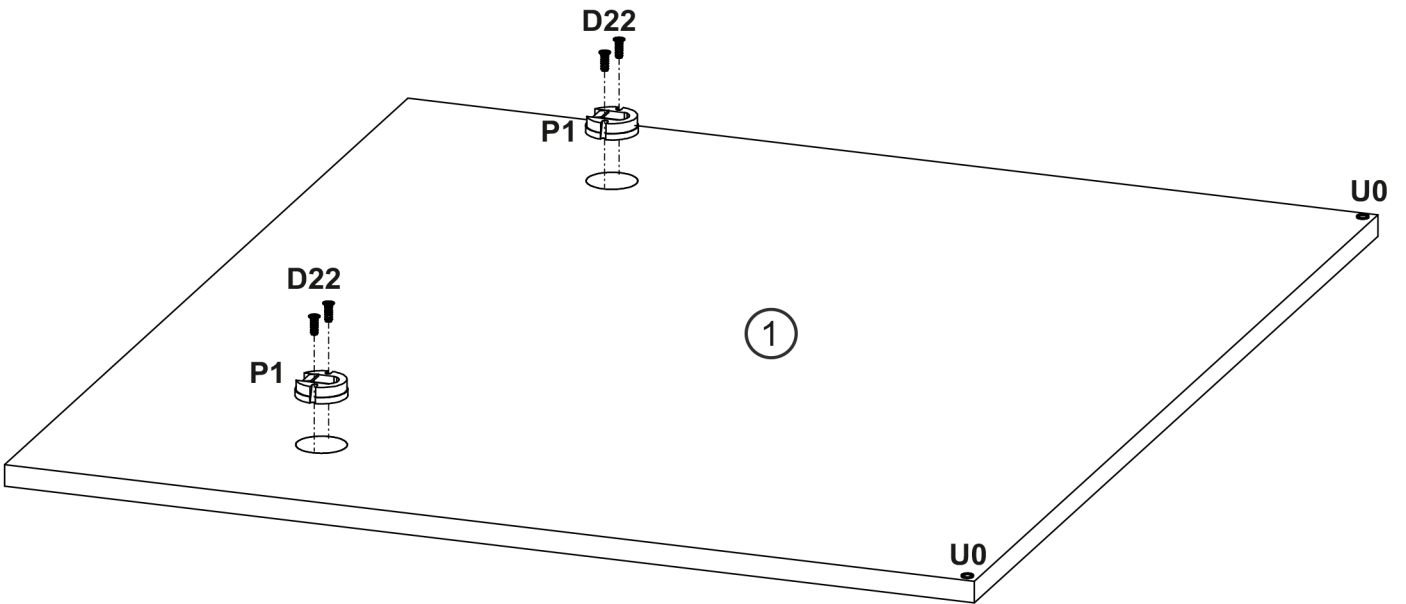
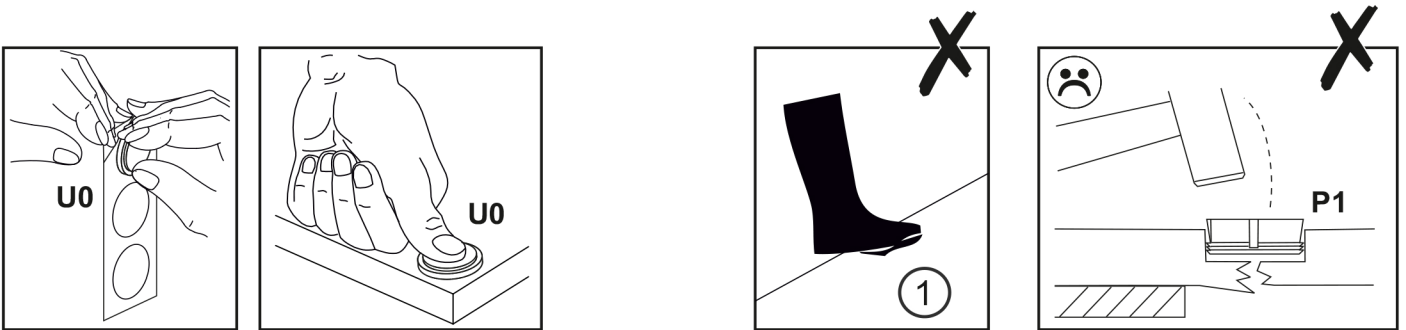
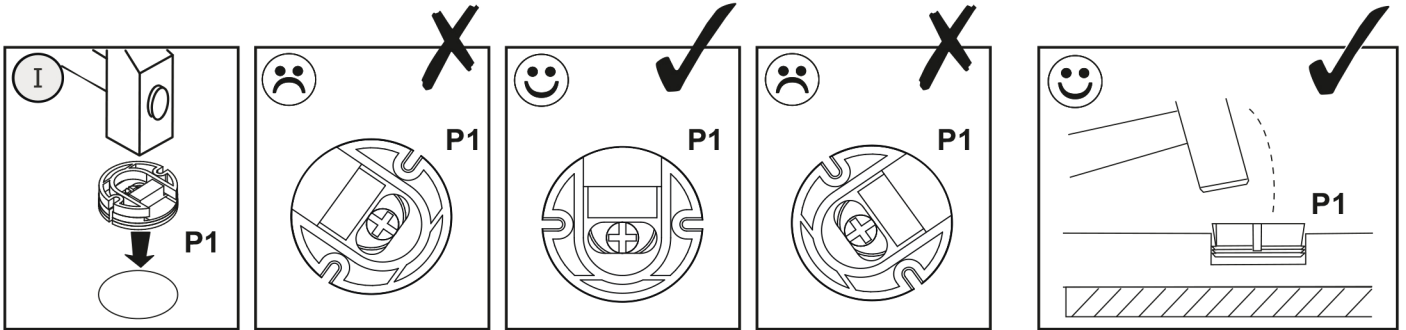

2

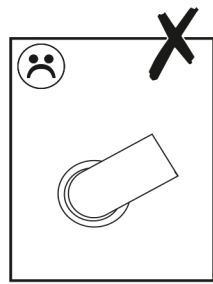
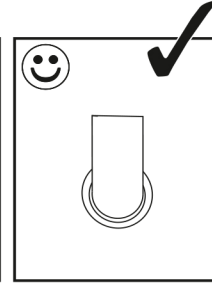
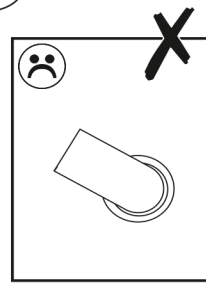
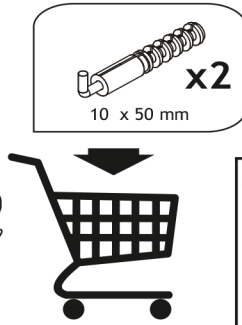
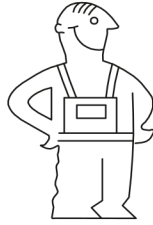
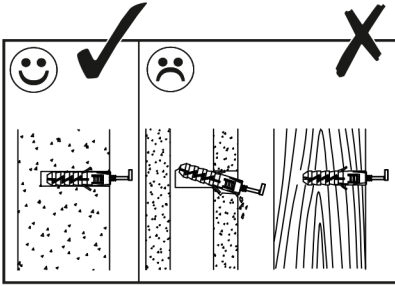

Ø10 mm

Ø10 mm

575 mm

b



b

